



VINTAGE COLONIAL

Our beautiful VINTAGE line was created to give your projects a luxurious and contemporary touch with very slim profiles. An excellent option for a classic or minimalist style.

Specifications

- French Outswing and Fixed configurations available
- Minimalistic design
- Multi point lock hardware
- From 3 to 5 glass lites
- Optional electronic access control

CERTIFICATIONS

<https://n9.cl/prm71p>



FBC
CERTIFICATE

<https://n9.cl/0bdlp>



GALLERY



HURRICANE AND
IMPACT RESISTANT
WINDOWS & DOORS

FL# - FL47205

Uni-K
FENESTRATION

VINTAGE COLONIAL

LMII:

- Frame depth: 4" or 6"
- Design load: 60 PSF
- Maximum panel size: 48" Width x 144" Height

- Air infiltration: 6.27 PSF
- Water infiltration: 9 PSF

Glass Options:

- Laminated

Our glass is certified by SGCC and IGCC, ensuring that our processes always deliver the highest quality

Frame Options

Vertical section
Option A

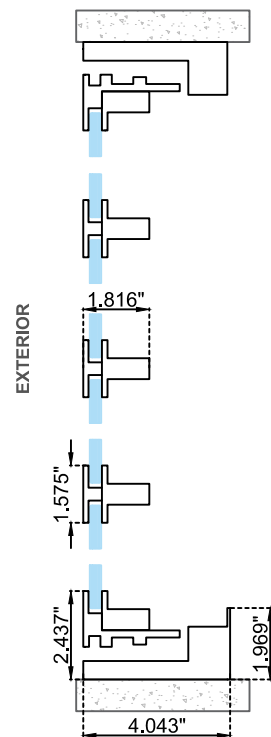

Only available for Types:
A - B

Vertical section
Option B

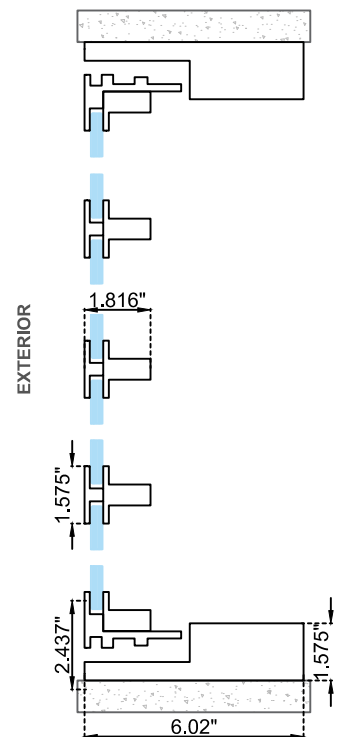

Available for all Types



TYPES

A. Single door

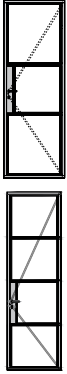

Horizontal section Option A

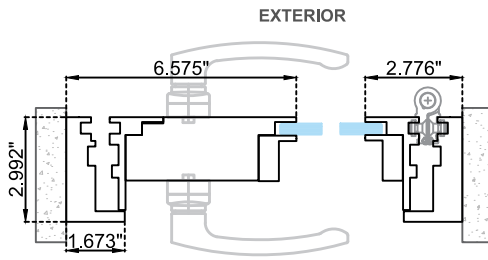

Horizontal section Option B

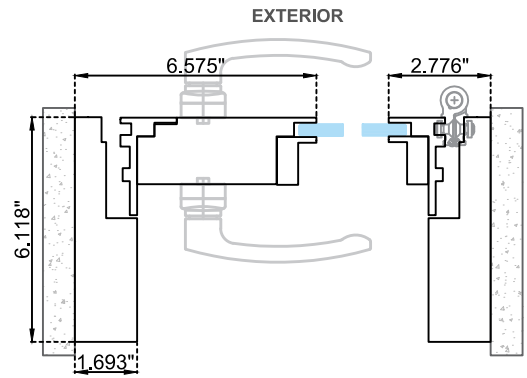

B. Double Door

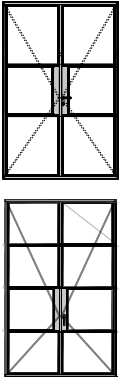

Horizontal section Option A

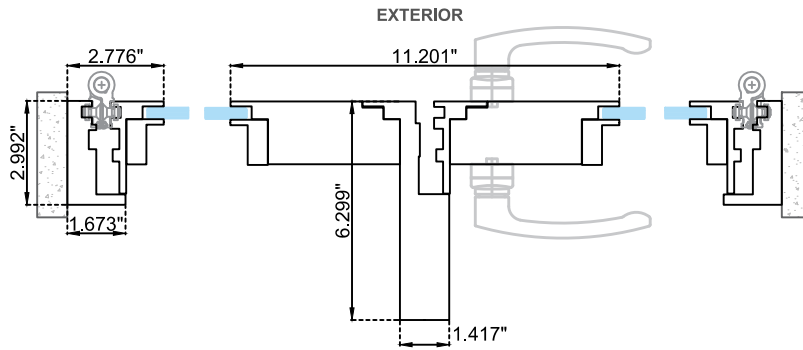

Horizontal section Option B

C. Double Door + Fixed

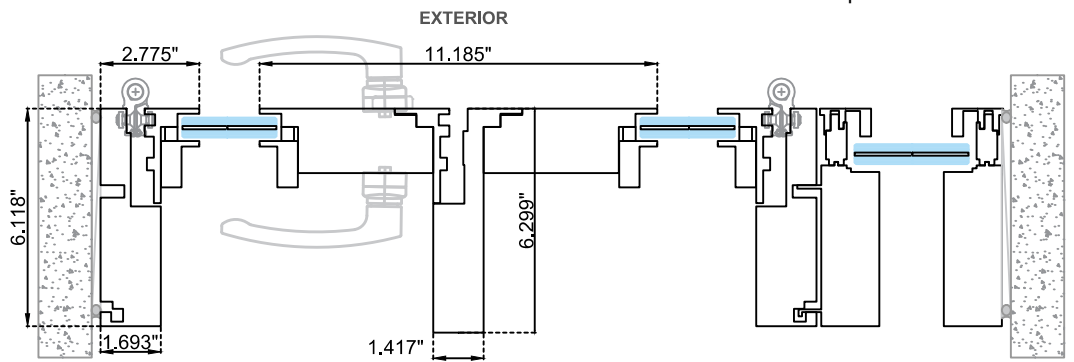
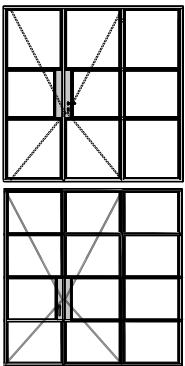

D. Double Door + Fixed

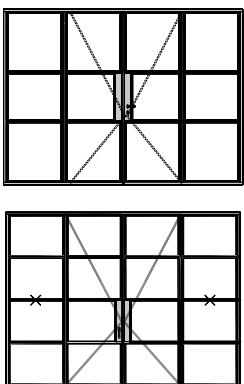

Horizontal section Option B

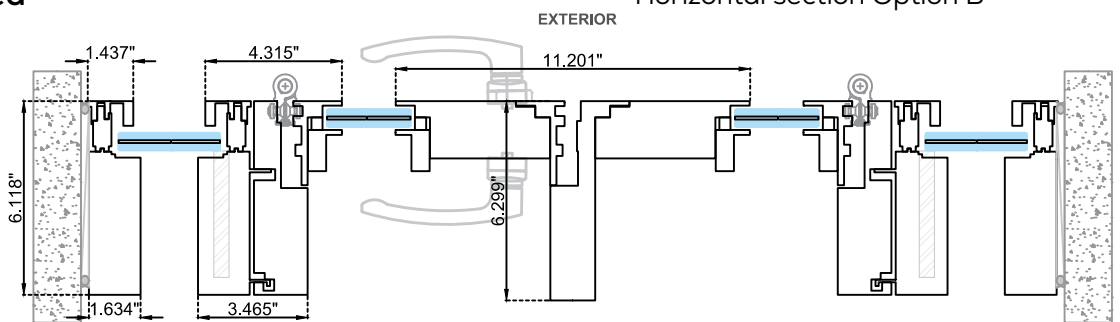

COLORS

DC04 Grey



DC05 Dark Grey

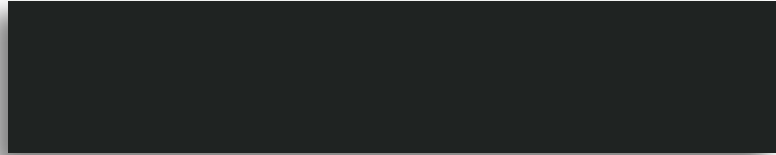

DC12 Black



DC11 Bronze



MA07



MA08

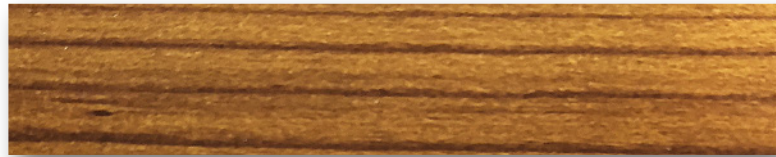

MA09

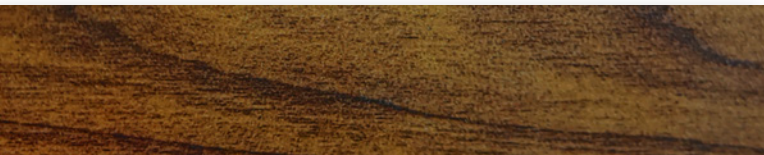

MA10

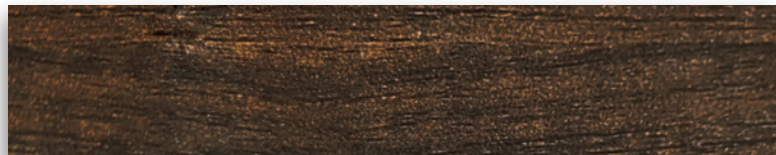

Uni-K
FENESTRATION

+305 420 6910

info@unik-windows.com

  @unik.windows

Download this brochure
with this QR



or visit our website
www.unik-windows.com